

WALLE

DN 20°, 00 m KN M: 1 : 100

Ausdruck: 13.11.2007 11:55:58

Bauherr:

Bauort:

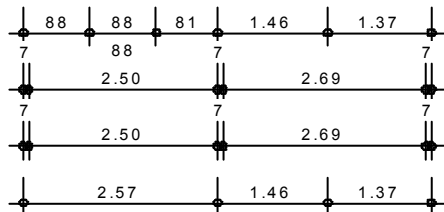
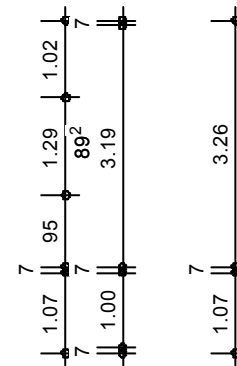
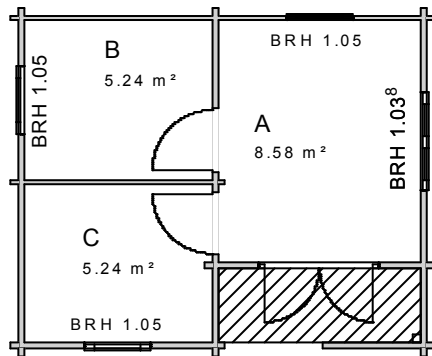
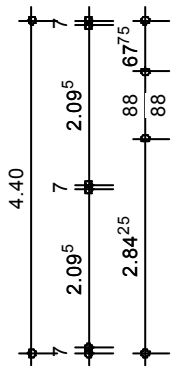

Erdgeschoss

Datum, Unterschrift des Bauherrn (Ehemann)

Datum, Unterschrift des Bauherrn (Ehefrau)



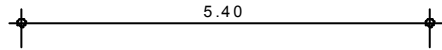

WALLE

DN 20°, 00 m KN M: 1 : 100

Ausdruck: 13.11.2007 11:55:52

Bauherr:

Bauort:

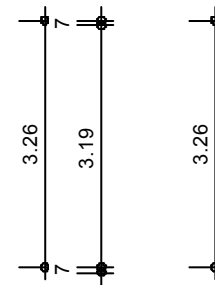
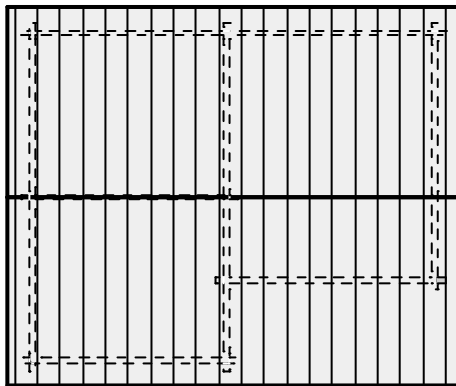
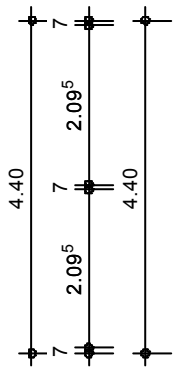

Datum, Unterschrift des Bauherrn (Ehemann)

Datum, Unterschrift des Bauherrn (Ehefrau)

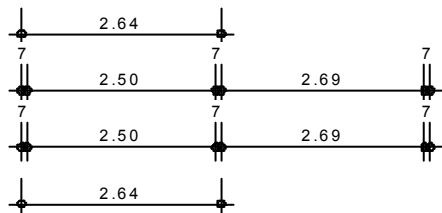

Dachgeschoss



